

1953 International R-110

Thank you for purchasing our kit. We offer articles and video tutorials on our website that focus on the basics such as painting, assembly, and preparation of 3D printed items. Additionally, product spotlights and other interesting model railroad related articles and videos are available on our website.

Visit us at custommodeldepot.com

The 1953 International R-110 from Custom Model Depot is an accurate representation of the prototype, scaled to actual dimensions. The basic requirements for building the kit are 400 grit sandpaper, cyanoacrylate glue (super glue), and an Xacto Blade.

Introduced in 1953 as the replacement for the International L series, the R series Internationals sported the IH "tractor" grille emblem. The R series were powered by Silver Diamond 220 inline-6 engine producing 100 hp through a 3 speed transmission. Along with a redesign of the grill in 1953, International introduced the Travelall, a pickup based station wagon. The Travelall became a competitor of the Chevrolet Suburban, introducing a number of feature before Chevrolet.

WARNING:
This kit is not a children's toy.
Not made for kids under 14 years old.

WARNING:
CHOKING HAZARD
Not for small children

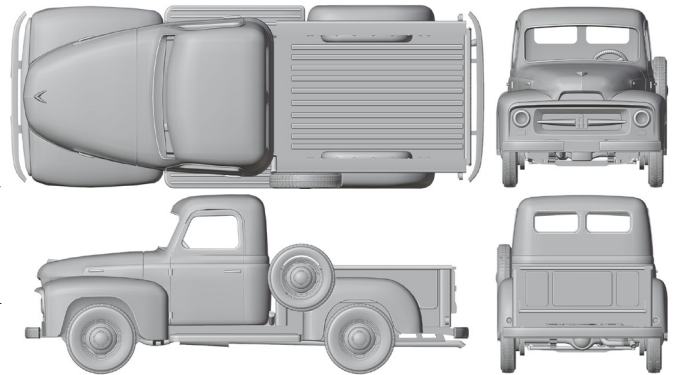

Cyanoacrylate Adhesive
is recommended.

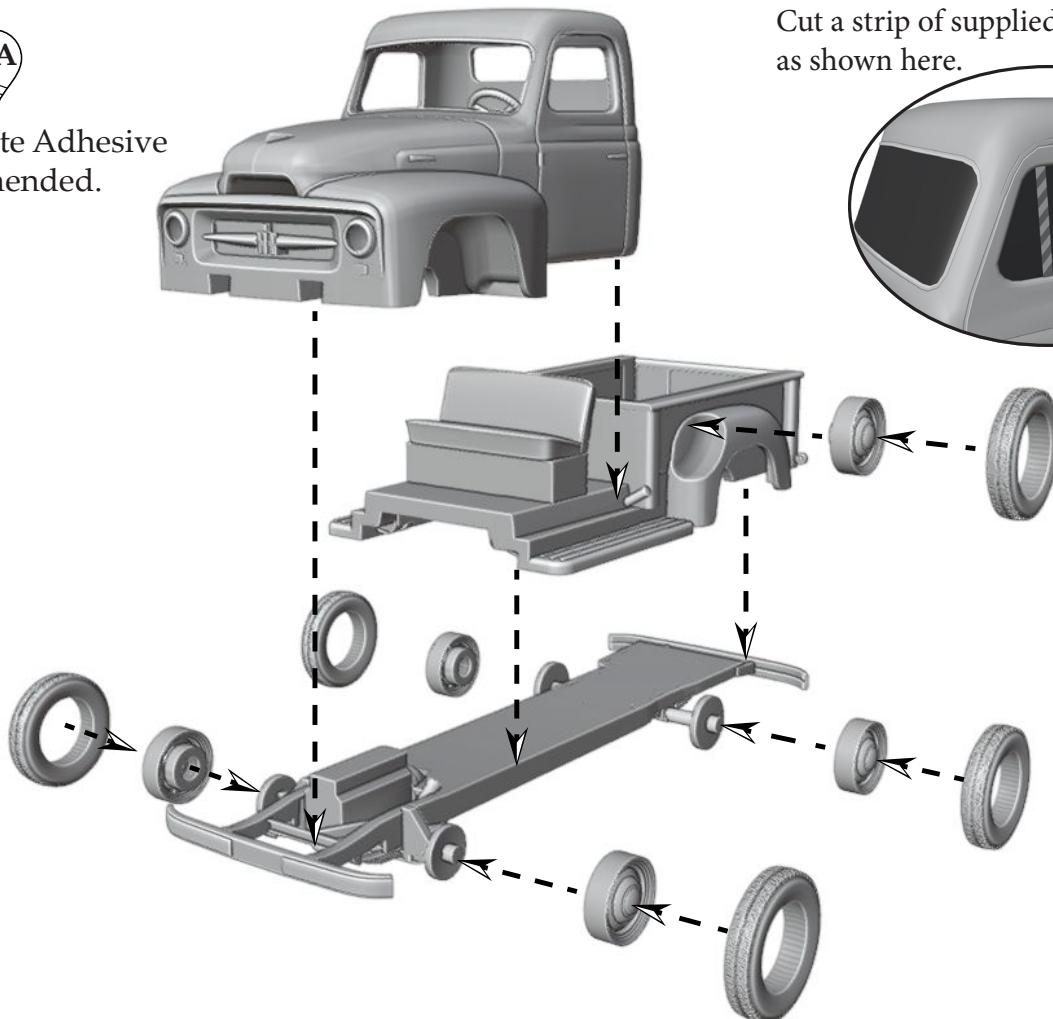

Cut a strip of supplied foil and apply
as shown here.

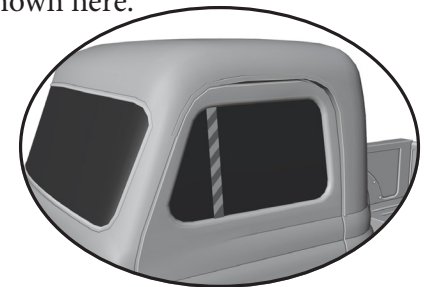

General Tips & Tricks

Assembling a 3D printed resin kit can be a challenge to some. With this in mind we've provided the following information to help you get the best results.

There are several ways to add window glazings to models, but we've found that the easiest method is to use clear scotch tape. Cut a small section of tape and apply it to the window opening. Watch out for fingerprints! Line up the bottom edge of the tape with the edge of the opening. Press the tape on the model gently by hand then burnish the edge with either a pencil or a toothpick to ensure that the tape is adhered to the very edge of the opening. Now that the tape is attached, use a No. 11 blade to cut the tape just along the face of the opening. Cutting too close to the edge may cause you to slip or have the tape come undone over time, so take care. Once the tape is fully cut out, it's best to burnish the edge once more.

Paint prep is a critical step to getting a perfect result. Use 400 grit sandpaper to remove any layer lines, use small pieces of sandpaper to avoid sanding areas you do not intend to sand. Use an assortment of small files to get in hard to reach areas. Fine steel wool can remove some light scratches and layer lines, but don't go too far or detail can be lost in some areas. An alternative way to prep the body of a vehicle is a Dremel tool and a small scotch bright wheel. This is a more advanced method and great care is required so as to not ruin the model, proceed at your own risk!

Sometimes, resin printed models can warp over time, less so once painted. If you encounter a model which is warped, this can be fixed very easily by putting the model in hot water for a few seconds, once the model feels soft, bend it to the correct position. While holding the model in shape, cool it rapidly with cold water. Repeat if necessary.

Before painting your model, ensure that it is clean and free of oils. Soap and water can be used to clean the model with a soft brush. Allow the model dry completely. When preparing to spray the model, quickly spray down the paint booth with water to capture any dust that may fall onto the model as you are painting it. Thin your paints accordingly, light coats are a must. Enamel paints are our go to for a shiny finish. If you are brushing on a coat of paint, use thin coats of acrylic paint to get the best results.

For painting details it is recommended to use a 0/0 brush. For chrome, we use Molotow Liquid Chrome markers. Press some of the paint out of the marker on a piece of plastic, then use a fine brush to apply it to the model.

For headlight lens, we use clear UV resin to create a realistic looking lens. You can use either acrylic paint or clear glue like Microscale Krystal Klear.

Applying a clear coat to the model can add to the finish of the model and hide minor imperfections. Be sure to follow the recommended practices provided by the manufacture, thin the product and apply light coats till the desired effect is achieved.

We hope that these tips helped you along in some way, the most important part of any model making is patience.

